

Cape Cod

Finished Wood Siding

www.capecodsiding.com

INSTALLATION, STORAGE AND WALL CONSTRUCTION DETAILS

IMPORTANT – READ THE FOLLOWING INSTRUCTIONS CAREFULLY BEFORE INSTALLING YOUR WOOD SIDING. FAILURE TO STRICTLY FOLLOW THESE INSTALLATION, STORAGE AND WALL CONSTRUCTION INSTRUCTIONS WILL VOID ALL WARRANTIES. FOR DETAILED SHINGLE INSTALLATION INSTRUCTIONS PLEASE REFER TO THE INSTRUCTION INSERT INCLUDED IN THE SHINGLE BOX.

The following installation instructions are created in accordance with the National Building Code of Canada. Please check with local authorities for applicable Building Codes in your area. If the National or Local Building Code requirements exceed these instructions, then that Code will apply.

IF THE TYPE OF CONSTRUCTION USED IS NOT DETAILED IN THIS INSTALL INSTRUCTIONS OR DOES NOT PERMIT NAIL PENETRATION THROUGH THE SIDING AND INTO A FULL 1 INCH OF SOLID WOOD BEHIND THE SIDING, STOP AND CALL 1-800-565-7577.

IT IS THE RESPONSIBILITY OF THE INSTALLER TO ENSURE THAT THE SIDING IS CORRECTLY INSTALLED. FAILURE TO STRICTLY ADHERE TO THESE INSTRUCTIONS AND ALL APPLICABLE BUILDING CODES WILL VOID THE WARRANTY AND AFFECT THE PRODUCT PERFORMANCE AND APPEARANCE.

1 BEFORE YOU START

Double check that the siding/trim colours and profile are correct. Should you find any product to be unsatisfactory DO NOT INSTALL IT. Contact a Cape Cod Siding Representative immediately at 1-800-565-7577. INSTALLATION OF EACH PIECE OF CAPE COD WOOD SIDING, CONSTITUTES AN ACCEPTANCE OF THE CONDITION OF THE SIDING PRODUCT PRIOR TO INSTALLATION.

2 PROPER STORAGE

- Store all siding on a flat, level surface, off the ground.
- Protect all siding and trim boards from the elements by storing them under a roof or a waterproof covering.
- All siding and trim boards MUST be dry prior to installation.

When opening the bundles of siding on the jobsite, cut the lumber wrap along the dotted line at the bottom of the bundle. Save the plastic wrap that is under the lumber wrap to help cover the siding.

3 PRIOR TO INSTALLATION

- Install an approved house wrap in accordance with the manufacturer's instructions, if required by Code.
- Properly seal and flash all openings, including over window and door trims, to prevent moisture intrusion or water build up.
- Install rain gutter to deflect water from siding.
- Ensure all wall cavities are dry prior to siding installation.
- Ensure strapping is installed on 12 or 16 inch centers (refer to sections 5, 6, 7, 8 & 9).
- For siding and trim installation on structures that are less than 10 meters away from an open body of water ("Extreme Exposure Conditions") the Siding must be pressure treated for the Warranty to be valid. It is also recommended that in all high moisture conditions that pressure treated siding and trims be used.
- Cape Cod Siding is designed for vertical wall installation applications. For wall installation other than 90 degrees stop and contact Cape Cod Siding prior to installation.

4**IMPORTANT INSTALLER RESPONSIBILITIES**

- Paint/seal all field cuts with Cape Cod Siding colour matched touch-up paint.
- Use the plastic hammer caps provided with the Cape Cod Siding nails to protect the paint on the nail heads.
- Cape Cod Siding and trims **MUST** be installed on strapping to create an airspace (see sections 5, 6, 7, 8 & 9).
- Butt joints **MUST** be tight and made over solid wood strapping. For best results we recommend mitering at 22°.
- **DO NOT** lift siding boards to re-align. Boards may unlock if lifted. If required, adjustment or re-alignment can be achieved by cutting along the top of the siding and painting the field cut with Cape Cod touch-up paint.
- Use a jig block to obtain a 1/16 inch clearance between rabbeted/shi lap joints.
- To provide a proper nailing base at corners and openings, install additional framing lumber with the wide surface against the sheathing on the inside of the wall cavities. (see section 14).
- Always install Cape Cod Siding on kiln dried or thoroughly air dried lumber. If the strapping is not dry it will shrink and its nail holding ability will be compromised, resulting in unwanted movement of the siding/trim boards.
- Use Cape Cod colour matched nails.
- Always flash over the top of all wall openings such as window and door trims. Allow a 3/8 inch gap (capillary break) between the flashing and the siding.
- Wood siding **MUST** be nailed into a full 1 inch solid wood nailing base.

5**INSTALLING STRAPPING**

Always install strapping on maximum spacing of 16 inch centres and have a screened open ventilated bottom and blocking at the top to create a rain screen.

- Always install the strapping over house wrap and ensure that proper airflow and drainage is maintained.
- Use 10mm (3/8 inch) thick strapping when the strapping is installed directly over sheathing and studs.
- Use 25 mm (full 1 inch) thick strapping when the strapping is NOT installed directly over studs.
- Horizontal strapping requires ½ inch drainage slots every 48 inches.
- For VERTICAL SIDING (8 inches and wider), the strapping **MUST** be installed on 12 inch centres.
- Use strapping to fur out windows. The window strapping should be the same thickness as the strapping used to install the siding.

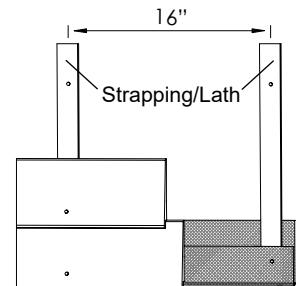

Full 1 inch pressure treated strapping is available from Cape Cod Siding through your local building supply dealer.

6**INSTALLING HORIZONTAL SIDING**

- If HORIZONTAL SIDING is installed over solid sheathing (plywood, OSB) and applied directly over studs, then a minimum strapping thickness of 10mm (3/8 inch) is permissible.
- If the strapping is NOT applied directly over studs, then 25mm (full 1 inch thick) strapping **MUST** be used.
- In order to provide a proper nailing base at the ends of the siding around windows, doors and corners, it may be necessary to install additional framing lumber with the wide surface against the sheathing on the inside of the wall cavities. (see section 14).
- Siding **MUST** be nailed into a full 1 inch solid wood nailing base.

Full 1 inch pressure treated strapping is available from Cape Cod Siding through your local building supply dealer.

7**INSTALLING VERTICAL SIDING**

- If VERTICAL SIDING is installed over solid sheathing (plywood, OSB), use full 1 inch thick kiln dried or thoroughly air dried horizontal strapping. **The use of 1 x 3 material is NOT ACCEPTABLE FOR VERTICAL SIDING AND WILL VOID THE WARRANTY.**
- Use double strapping to achieve a rain screen.
- To install double strapping, first install 10 mm (3/8 inch) vertical strapping over the studs and then install full 1 inch strapping horizontally on 16/12 inch centres. (see section 8)
- If double strapping is not used, install full 1 inch kiln dried or thoroughly air dried horizontal strapping with ½ inch drainage slots every 48 inches (between the studs) to allow for a drainage plane and to achieve a rain screen.
- For VERTICAL SIDING (8 inches and wider), the strapping **MUST** be installed on 12 inch centres.
- For VERTICAL SIDING (6 inches wide or less), apply strapping on 16 inch centres, with a ½ inch drainage slot every 48 inches.
- When installing VERTICAL SIDING on a diagonal, the strapping **MUST** be 12 inches on center and be a full 1 inch thick.

Full 1 inch pressure treated strapping is available from Cape Cod Siding through your local building supply dealer.

8

INSTALLING CAPE COD SIDING OVER RIGID INSULATION

Where rigid insulation is used as a sheathing or installed over plywood or OSB sheathing:

- A full 1 inch kiln dried or thoroughly air dried strapping **MUST** be used.
- Nail or screw the strapping through the insulating sheathing into the studs.
- Ensure that the fasteners are adequate in length to fully secure the strapping, as fasteners will be holding the entire weight of the siding and trims.
- For HORIZONTAL SIDING installation: full 1 inch strapping must be installed on 16" centers over the studs.
- For VERTICAL SIDING installation: it is recommended that the full 1 inch strapping be installed with 1/2 inch drainage slots every 48 inches to allow for drainage and to achieve a rain screen.
- For VERTICAL SIDING installation (8 inches and wider): full 1 inch strapping **MUST** be installed on 12 inch centres.
- For VERTICAL SIDING installation (6 inches wide or less): full 1 inch strapping **MUST** be installed on 16 inch centres.

Full 1 inch pressure treated strapping is available from Cape Cod Siding through your building supply dealer.

9

INSTALLING CAPE COD SIDING OVER INSULATED CONCRETE FORM (ICF) WALLS

For HORIZONTAL SIDING:

- Install full 1 inch kiln dried or thoroughly air dried strapping over the plastic or metal strips every 12 or 16 inches.
- Use screws (not nails) spaced no more than 12 inches vertically to install the strapping
- Where the plastic or metal strips are not available (example: around bay windows) install a double layer of 1/2 inch pressure treated plywood from the edge of the window to the first and second plastic or metal strips nearest the window. Screw the plywood to both the first and second strips.

For VERTICAL SIDING (8 inches and wider):

- Install full 1 inch kiln dried or thoroughly air dried strapping on 12 inch centres with a drainage slot every 48 inches.

For VERTICAL SIDING (6 inches wide or less):

- Install full 1 inch kiln dried or thoroughly air dried strapping on 16 inch centres with a drainage slot every 48 inches.

Full 1 inch pressure treated strapping is available from Cape Cod Siding through your local building supply dealer.

10

FASTENERS

- Cape Cod Siding supplies stainless steel ring shank nails specifically designed for the application of Cape Cod Finished Wood Sidings and Trim boards. Failure to use Cape Cod Siding nails voids the warranty.
- Ensure the nail used is the correct length to enable penetration into a solid wood nailing base of a minimum of 25mm (1 inch).
- Always use the plastic hammer caps supplied by Cape Cod Siding to protect the finish on the nail heads.
- Cape Cod Siding supplies both 304 and 316 stainless steel nails. Use 316 stainless steel nails for all installations in "Extreme Exposure Conditions". (See section 3)
- Pre-drill nail holes near the ends of the siding boards to prevent splitting.
- Siding **MUST** be nailed at 1 inch from each end and at intervals no longer than 16 inches.(See sections 5 to 9)

11

NAILING INSTRUCTIONS

CONDITION

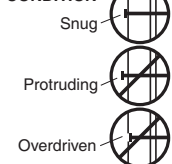

CORRECTION

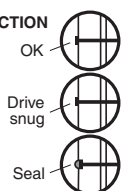

- Use Cape Cod Finished Wood Siding Nails.
- **NAIL AT 12 OR 16 INCH CENTERS.** (See sections 5 to 9)
- Drive nails so the head is just in contact with the siding surface.
- **IF NAILS ARE DRIVEN BELOW THE SURFACE, THEY MUST BE SEALED. FAILURE TO DO SO VOIDS THE WARRANTY.**
- **NAILS MUST PENETRATE INTO 1 inch of SOLID WOOD.**
- Siding and trim **MUST** be nailed within 1 inch of the end of the siding/trim boards.

12 NAILING HORIZONTAL SIDING - SIDE VIEW

Cove, Euro Channel & Double Rhombus
(6 inch & 8 inch widths)

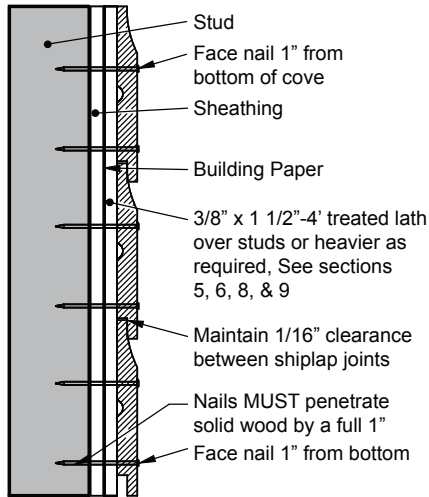

Clapboard
(6 inch & 8 inch widths)

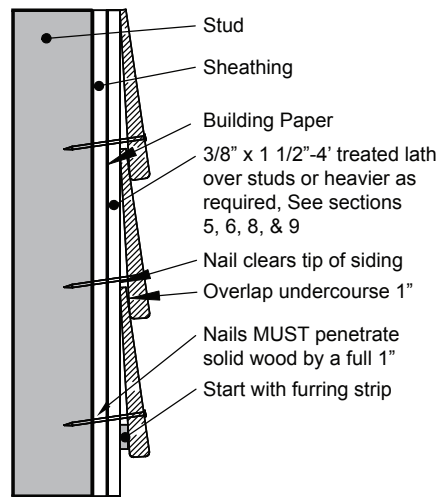

Rabetted Bevel
(4 inch, 6 inch & 8 inch widths)

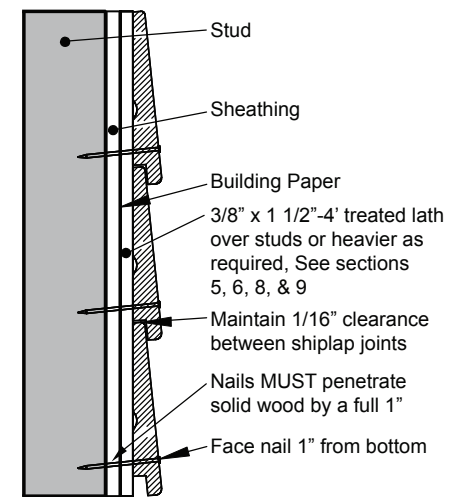

13 NAILING VERTICAL SIDING - TOP VIEW

The installer MUST use a minimum thickness of 1 inch kiln dried or thoroughly air dried strapping (see sections 5, 7, 8 & 9).

V-Joint
(6 inch & 8 inch widths)

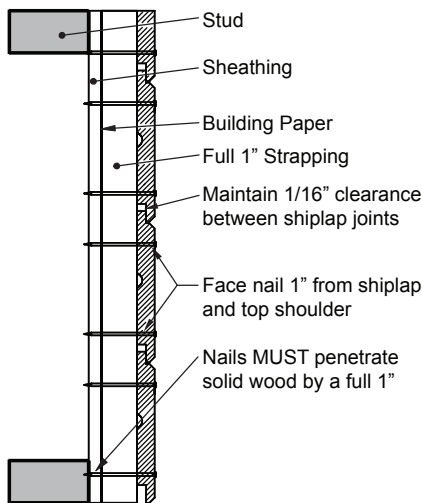

Channel, Euro Channel & Double Rhombus
(6 inch & 8 inch widths)

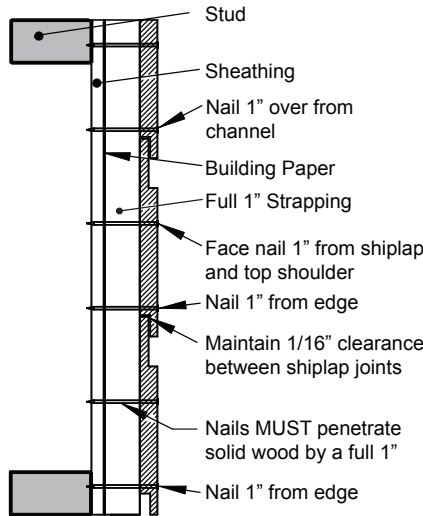

Board & Batten
(8 inch & 10 inch widths)

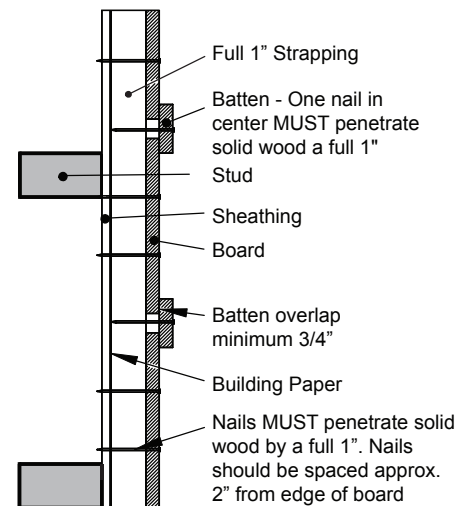

14 TYPICAL CORNER AND WINDOW TRIM DETAIL

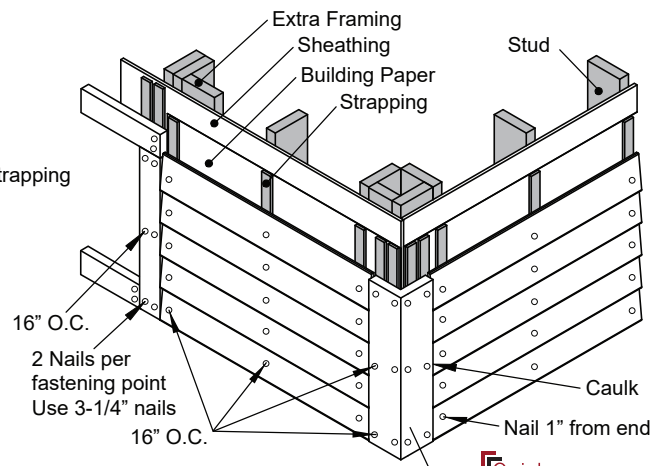
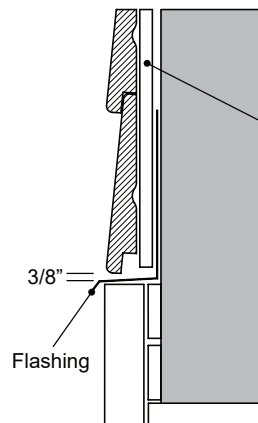
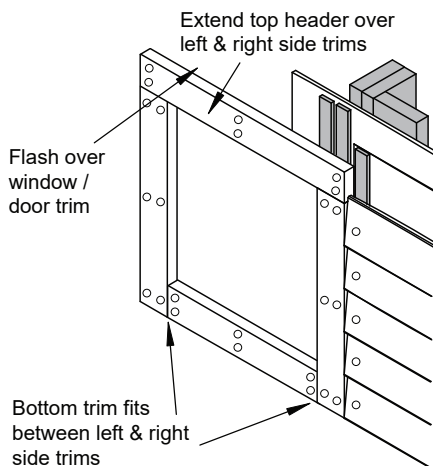

15 TYPICAL DORMER DETAIL

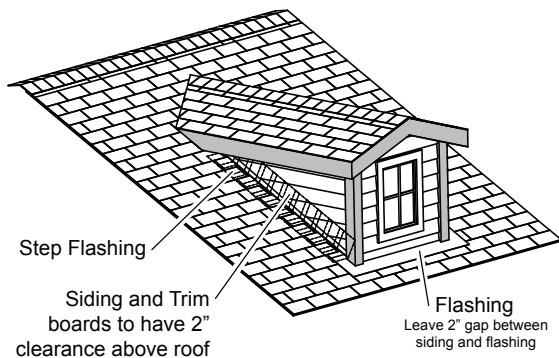

16 TYPICAL FASCIA & FREISE DETAIL

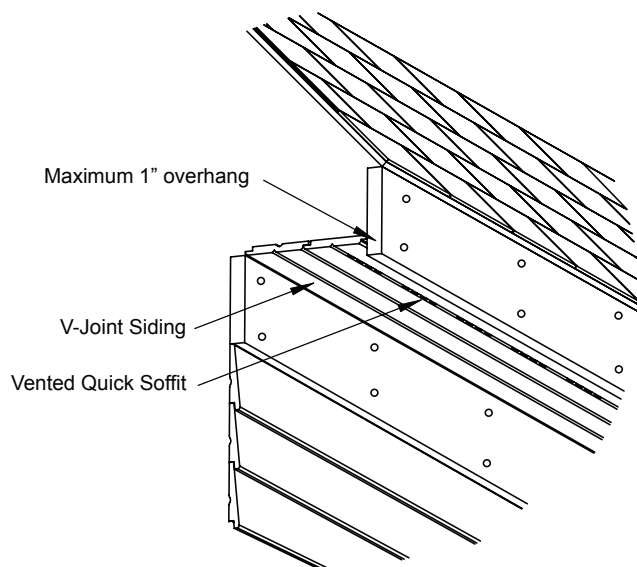

- Vented Quick Soffit is available from Cape Cod Siding through your local building supply dealer.

17 CLEARANCES

The siding and trim boards MUST:

- Allow a minimum of 8" above the grade.
- Allow a minimum of 2" above the roof.
- Allow 1" above decks and thresholds.
- Allow a 3/8" space between top of the flashing and siding.

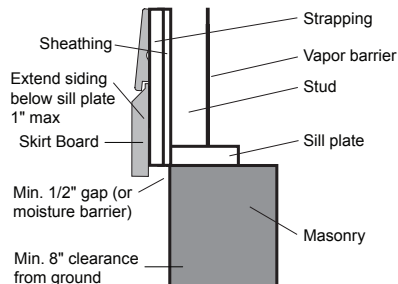

18 CAULKING

- Cape Cod Siding recommends the use of exterior grade, high-performance acrylic or urethane caulks and sealants to seal gaps around windows, doors, corners, and other exterior joints that are exposed to potential water intrusion.
- Caulking is not a permanent solution and will require regular maintenance. If not regularly inspected and maintained, caulking may fail and trap water, creating severe moisture problems.
- DO NOT CAULK AREAS THAT WILL PREVENT MOISTURE FROM ESCAPING THE WALL CAVITY (e.g., under windows and around flashing). Avoid three-sided adhesion. The caulk should only adhere to the two surfaces that create the opening in the surface plane, not to any rigid substrate behind.
- For gaps wider than 1/4 inch, insert a backer rod into gaps where caulk seals are to be made, and then caulk over.
- Always follow the caulking manufacturer's recommendations.

19 PAINT ALL FIELD CUTS

Cape Cod Siding is a finished product that requires care in handling and installation.

- Ensure the touch-up paint does not freeze, if it does, DO NOT use it.
- Mix the touch-up paint thoroughly before applying.
- Ensure the touch-up paint matches the siding colour exactly by applying some paint to a test area and allowing it to dry before proceeding.
- Seal all field cuts with touch-up paint.
- Scratches and other damage to the siding caused by the installation MUST be repaired by the installer with touch-up paint. The application of the touch-up paint should be done with care.
- DO NOT touch-up nail heads or minor imperfections by applying the touch-up paint to the siding face. This may cause the touched-up areas to appear shinier than the siding. To correct this variance, an entire board or wall section should be painted to ensure colour consistency.
- If nail heads require touch-up; apply paint to nail heads only, using Paint Daubers included. Avoid painting the surrounding siding.
- Do not apply touch up paint to the face of the siding if the temperature is below 10 degrees Celsius.

20 GENERAL

- Horizontal installation only for Rabetted Bevel, Clapboard, Euro Channel and Cove siding.
- Vertical installation only for Board & Batten, Channel, Euro Channel, Double Rhombus and V-Joint siding.

AVAILABLE SIDING PROFILES

RABBETTED BEVEL

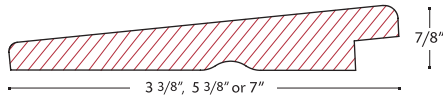

CHANNEL

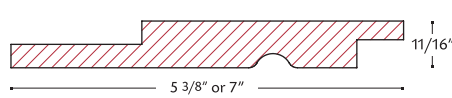

DOUBLE RHOMBUS

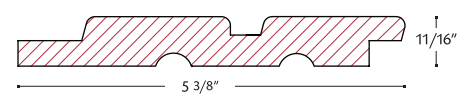

TRADITIONAL COVE

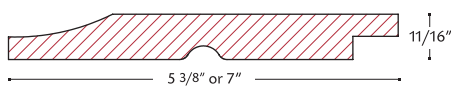

BOARD & BATTEN

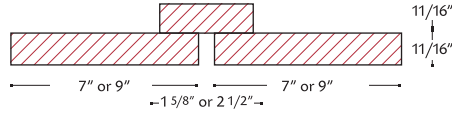

EURO CHANNEL

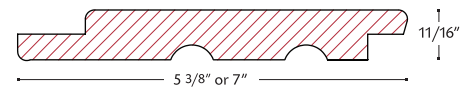

TRADITIONAL V-JOINT

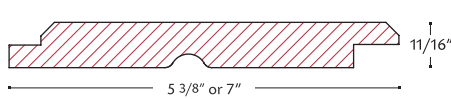

V JOINT - CENTER V

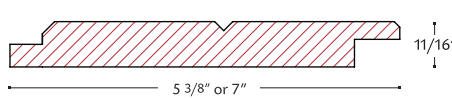

AVAILABLE TRIM PROFILES

TRIM DIMENSIONS (random lengths)

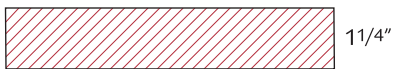

NOMINAL	ACTUAL
2 x 4	1 1/4" x 3 3/8"
2 x 5	1 1/4" x 4 1/4"
2 x 6	1 1/4" x 5 3/8"
2 x 8	1 1/4" x 7"
2 x 10	1 1/4" x 9"
2 x 12	1 1/4" x 11 1/4"



NOMINAL	ACTUAL
1 x 2	11/16" x 1 5/8"
1 x 3	11/16" x 2 1/2"
1 x 4	11/16" x 3 3/8"
1 x 5	11/16" x 4 3/4"
1 x 6	11/16" x 5 3/8"
1 x 8	11/16" x 7"
1 x 10	11/16" x 9"
1 x 12	11/16" x 11 1/4"

Quicksoffit

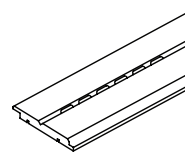
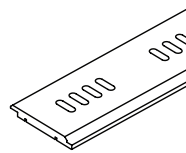
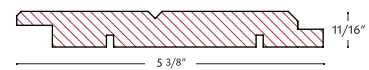
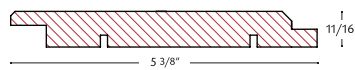

2.5 sq. inches airflow per lf.

Vented random length Soffit
Consult local building code to confirm proper ventilation rates required

1.05 sq. inches airflow per lf.

TRIM PROFILES

Quickcorner

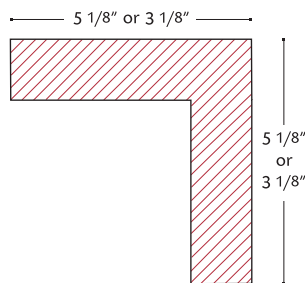

INSIDE CORNER

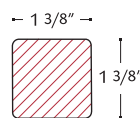

1 PIECE CORNER

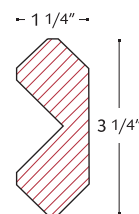

SKIRT BOARD

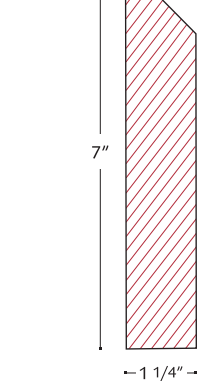

5 1/8" Quick corner available in 10 ft., 12 ft. and 16 ft. lengths
3 1/8" Quick corner only available in 10 ft. lengths

Inside corner and One piece corner are available in 10 ft. lengths

SILL TRIM

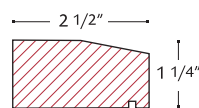

DRIP CAP/CROWN

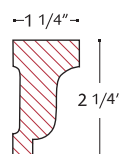

Learn more by scanning the code